

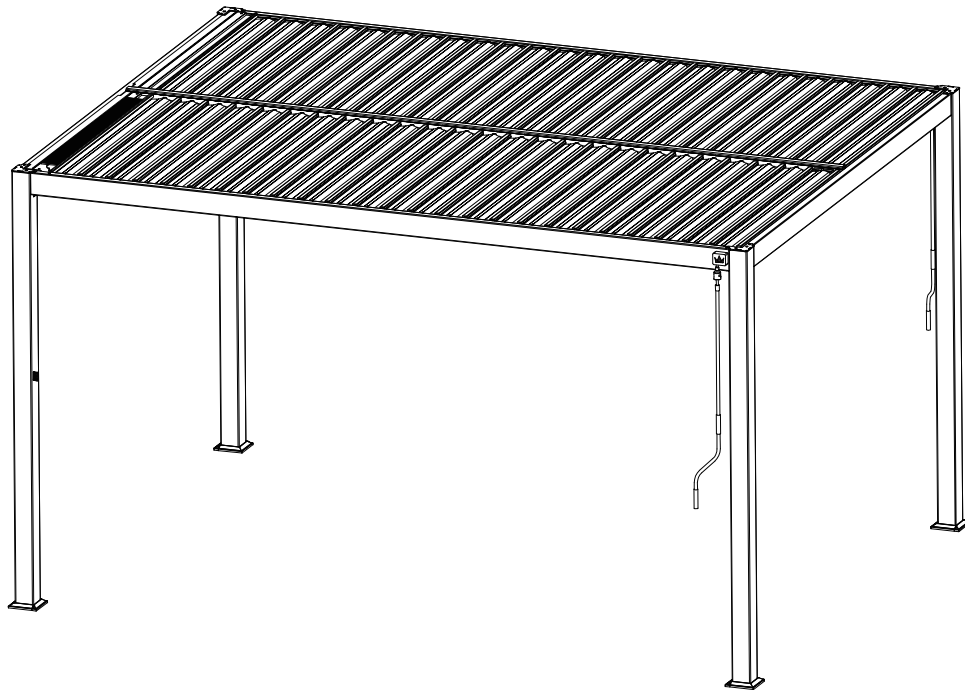

Assembly Manual

PURE 4X3M MANUAL LOUVERED ROOF LED PERGOLA





PLEASE KEEP THESE
INSTRUCTIONS
FOR FUTURE REFERENCE

ASSEMBLY VIDEO









COMPONENTS, FIXTURES AND FITTINGS PER BOX

Parts List – Box 1/5

Part No.	Diagram	Qty.	Part No.	Diagram	Qty.
A1	 Post	3 PCS	A2	 Post w/ Switch	1 PC

Parts List – Box 2/5

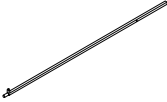
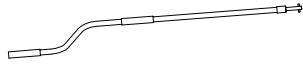
Part No.	Diagram	Qty.	Part No.	Diagram	Qty.
B1	 Front Beam-w/ Led Lights	1 PC	B2	 Back Beam-w/ Led Lights	1 PC
C	 Left/Right Beam-w/ Led Lights	2 PCS	D	 Middle Beam	1 PC
E1	 Louvre w/ Solar Panel	1 PC	E2	 Louvre w/o Solar Panel	1 PC
F	 Rotating Shaft	2 PCS	G	 Crank Handle	2 PCS





Parts List – Box 3/5





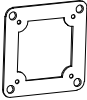
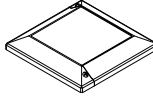
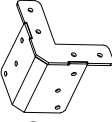
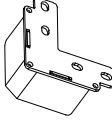
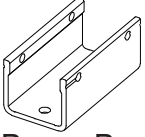







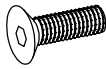
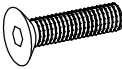

Part No.	Diagram	Qty.	Part No.	Diagram	Qty.
H	 Louvre	26 PCS			

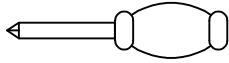
Parts List – Box 4/5

Part No.	Diagram	Qty.	Part No.	Diagram	Qty.
H	 Louvre	24 PCS			

Parts List – Box 5/5

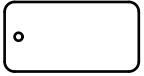
Part No.	Diagram	Qty.	Part No.	Diagram	Qty.
XA	 Post Base	4 PCS	XB	 Post Base Cover	4 PCS
XC	 Beam Connector	4 PCS	XD	 Post Connector	4 PCS
XG	 Mid Beam Bracket	2 PCS	XH	 Rotating Ring	2 PCS
EB	 M8*100 Expansion Bolt	16 PCS	M510	 M5*10mm Bolt	4 PCS

M518	 M5*18mm Bolt	28 PCS	M525	 M5*25mm Bolt & Nut	6 PCS
M615	 M6*15mm Bolt	16 PCS	M625	 M6*25mm Bolt	4 PCS
M820	 M8*20mm Bolt	40 PCS	M845	 M8*45mm Bolt	8 PCS
ST408	 Self-Taping Screw M4*08mm	192 PCS	SD	 Screw-Driver	1 PC
SP5	 M5 Spanner	1 PC	SP8	 M8 Spanner	1 PC
AK5	 Allen Key 5mm	1 PC	AK6	 Allen Key 6mm	1 PC
AK8	 Allen Key 8mm	1 PC	SL	 Spirit Level	1 PC
F2	 Space Plate	1 SET 1PC 2mm 1PC 3mm 1PC 5mm	TP	 Bottle of Touch Up Paint	1 PC

ASSEMBLY INSTRUCTIONS

Before you start:

- Read through this manual before you start assembly.
- Ensure you have all the parts listed in this manual, do not dispose of packaging until you have checked all parts.
- Ensure all parts are placed on a soft surface to prevent damage.
- Take care when lifting heavy/long parts.
- Keep small parts and tools out of the reach of children.
- It is of vital importance that your pergola is assembled in its desired location.
- It is vital your pergola is assembled on a solid level base.
- We advise the following equipment to be available which is not provided:

Extra Tools you may need(Not provided)

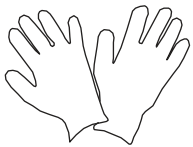

Gloves



Knife

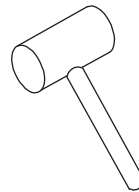

Hammer

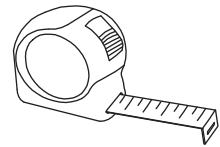

Tape measure

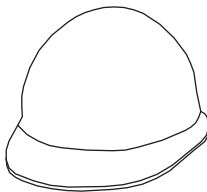

Safety Hat

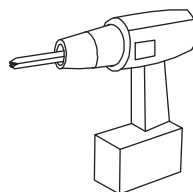

Electric Screw Driver

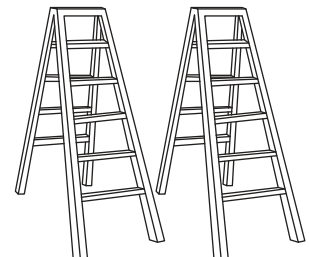

Ladder

DIAGRAM FOR THE MAIN PARTS

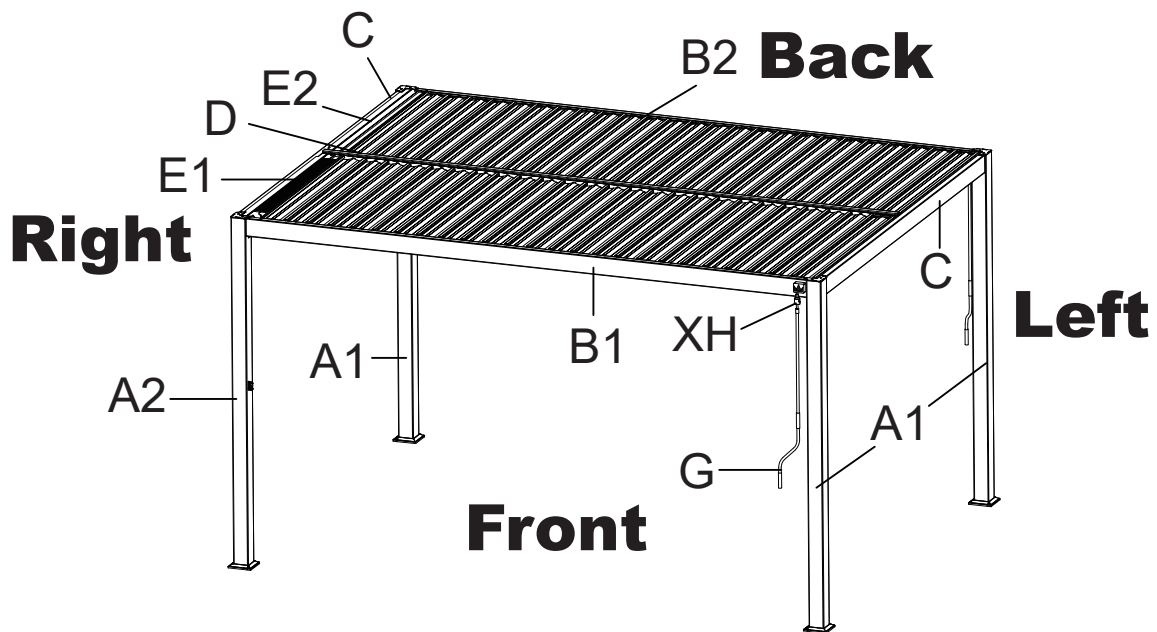

STEP BY STEP ASSEMBLY INSTRUCTIONS

Step One

Attach the Post Base Cover (XB) and Post Base (XA) to the Posts (A1) & Post (A2) using Bolts (M518).

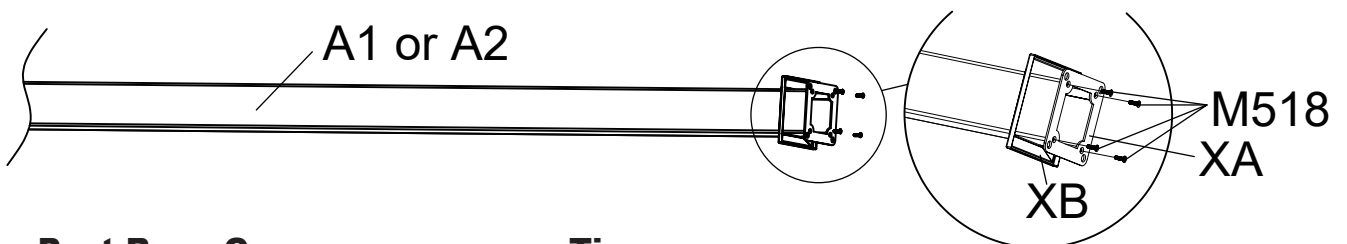

Post Base Cover

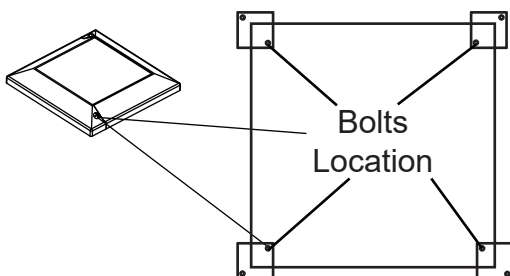

Tips:

Please make sure the Post Base Cover (XB) for Posts (A1 & A2) is assembled in Correct Direction. Please be noted the Bolts Location should face the Center of the Pergola. This step should be rechecked before the assembly of the Privacy Screens(Optional Parts).

Step Two

Attach Front Beam (B1), Back Beam (B2) and Left/Right Beam (C) together using Beam Connector (XC) and Bolts (M820).

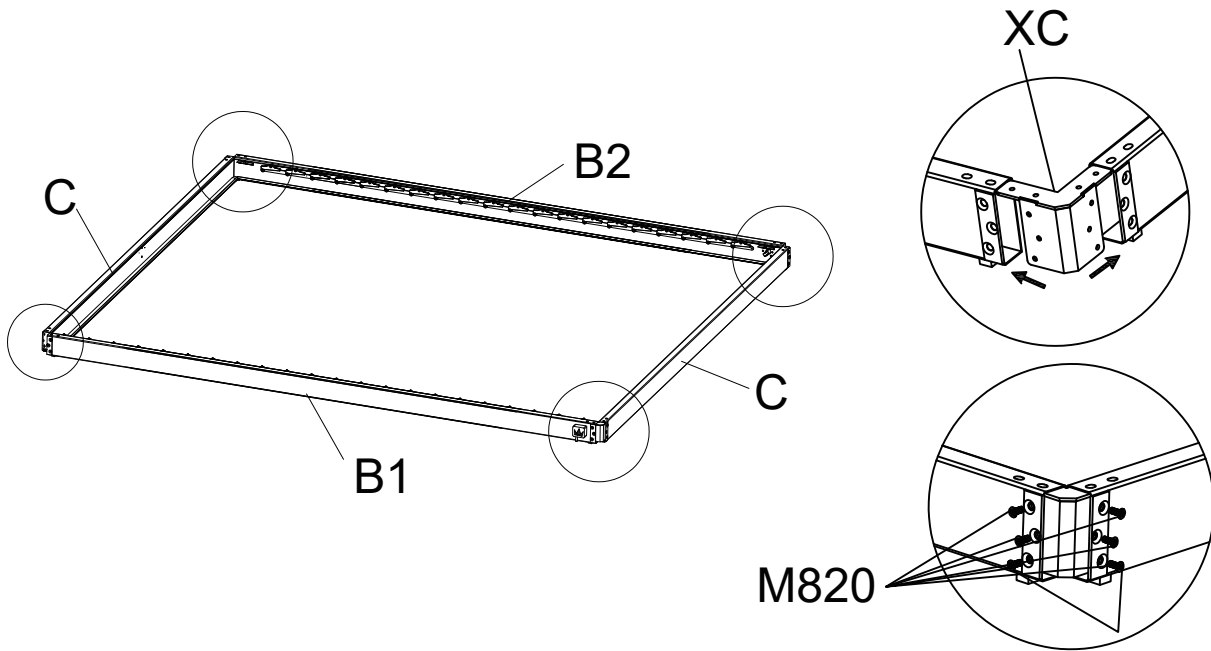

Step Three

Attach the Middle Beam Bracket (XG) to the Left/Right Beam (C) using Bolts (M615). Attach the Middle Beam (D) to the Middle Beam Brackets (XG) using Bolts (M615).

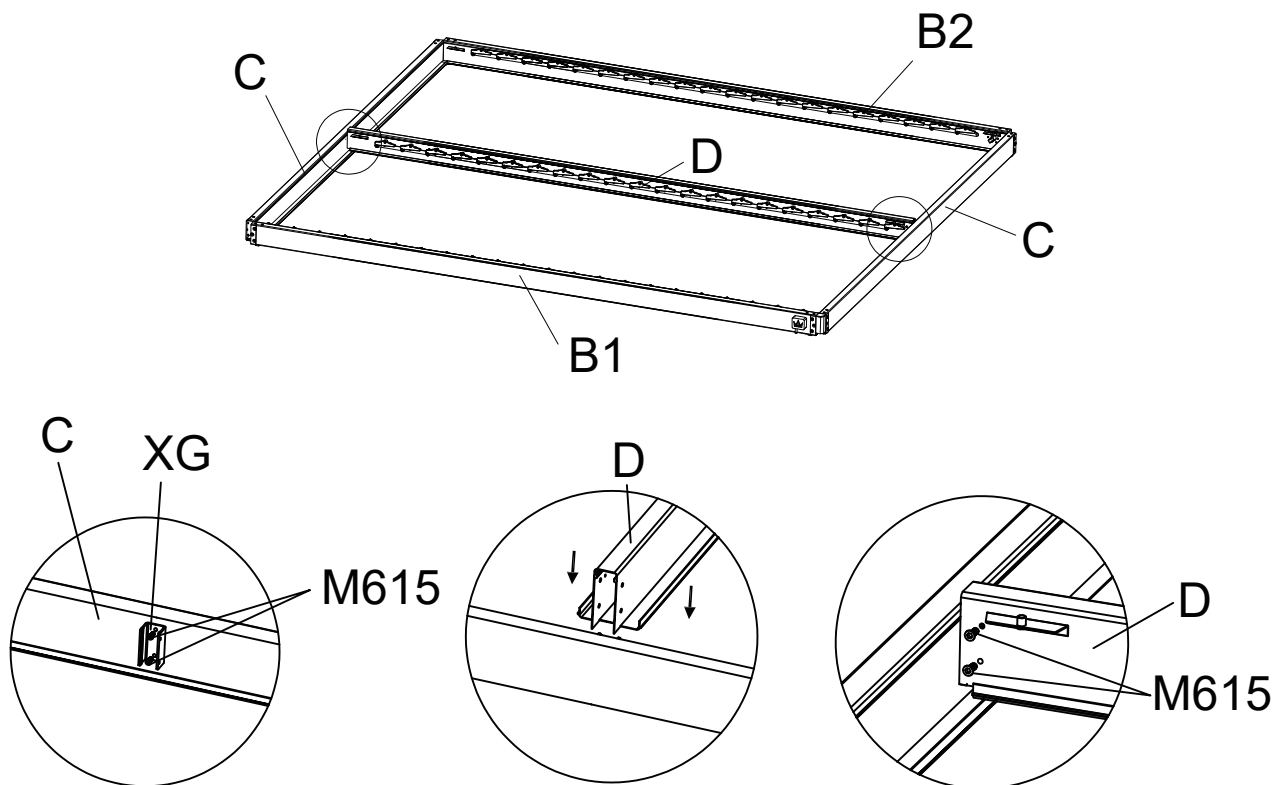

Step Four

Attach the Posts (A1) & Post (A2) to the Ends of the Beams using Post Connectors (XD), Bolts (M518), Bolts (M820) and Bolts (M845).

Please note the different location of the different bolts. Check carefully!

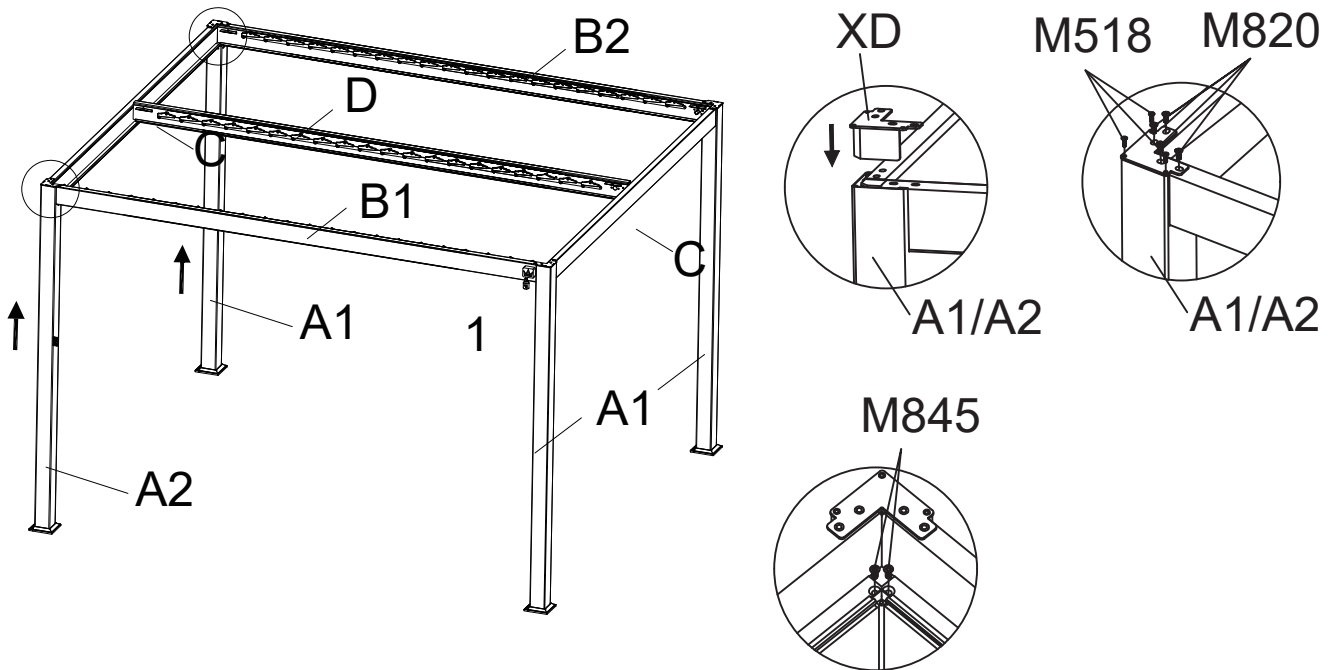

Step Five

Connect the Power Cable (Male and Female Connector) between the Post w/ Switch (A2) and Front Beam w/ Led Lights (B1).

Pull out the Led Lights Connector and Connect Led Lights as per below Sequence. A2-B1-C-B2-C, leaving the last one empty.

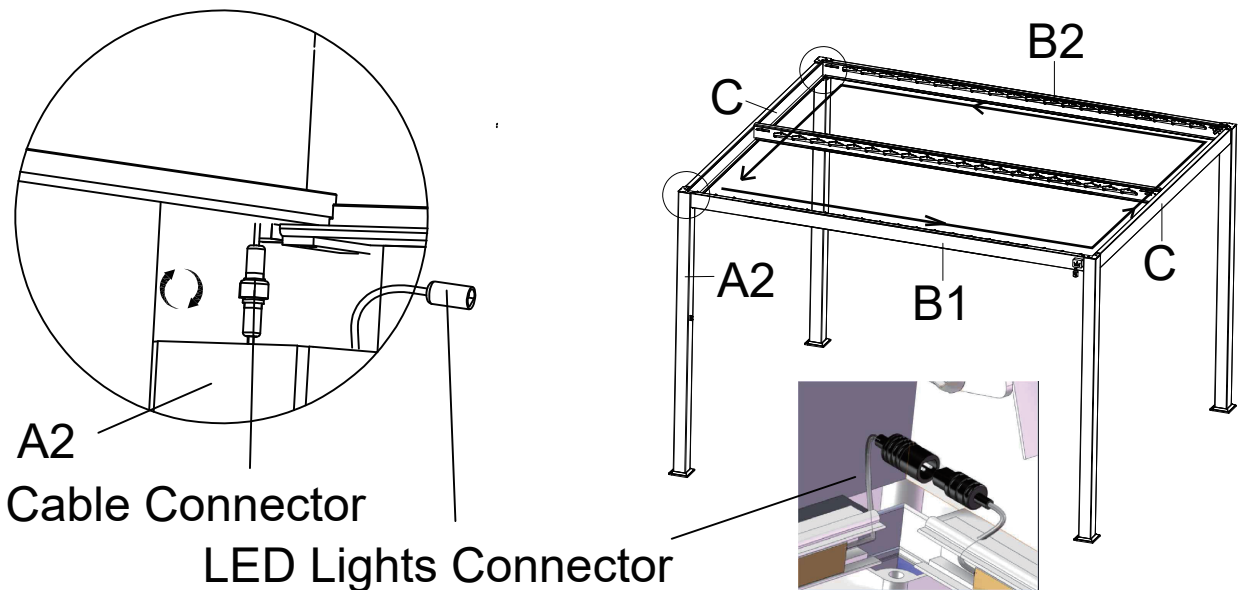

Step Six

1. Attach the First Rotating Shaft (F) to the Front Beam (B1) and Middle Beam (D) using Bolts (M525).
Please note the Square End of Rotating Shaft (F) is to be connected with the Front Beam (B1). Then Connect the Rotating Mechanism using Bolt (M510).
2. Attach the Second Rotating Shafts (F) to the Back Beam (B2) and Middle Beam (D) using Bolts (M525).
Please note the Square End of Rotating Shaft (F) is to be connected with the Back Beam (B2). Then Connect the Rotating Mechanism using Bolt (M510).

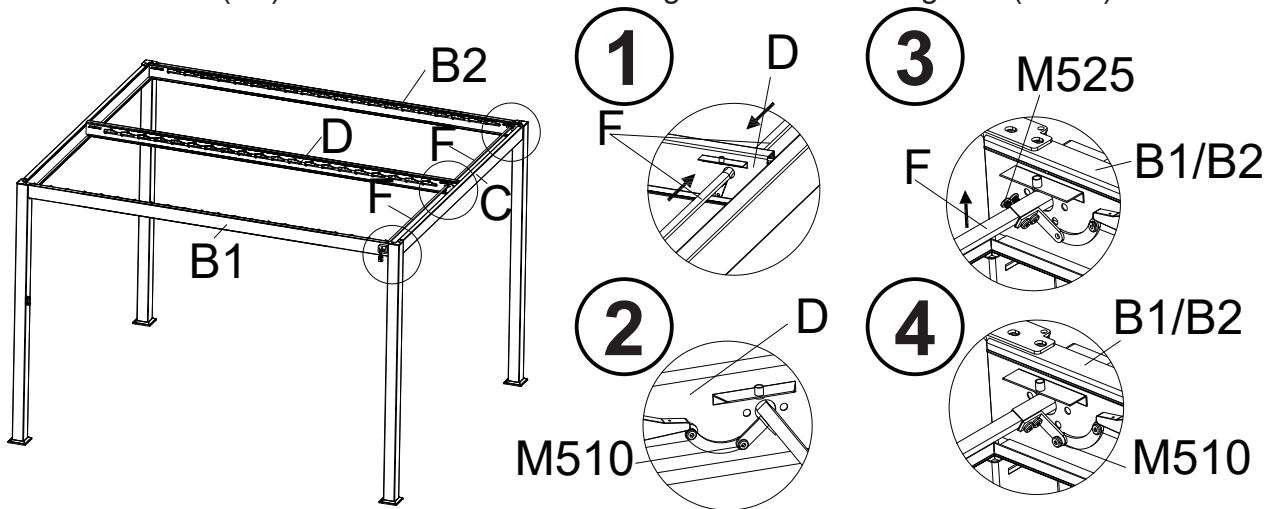

Step Seven

1. Attach the Rotating Ring (XH) to the Manual Motor using Bolts & Nuts (M525).
Note: There are two groups. Hang safely the Crank Handles (G) to Rotating Rings (XH).
2. Attach the Louvers (H) to the Front Beam (B1) & Middle Beam (C) near Right Beam (C) using Bolts (M615) for the 1st Piece and Self-Taping Screws (ST408) for the Balance Louvers (H).
3. Attach the Louvers (H) to the Back Beam (B2) & Middle Beam (C) near Right Beam (C) using Bolts (M615) for the 1st Piece and Self-Taping Screws (ST408) for the Balance Louvers (H).

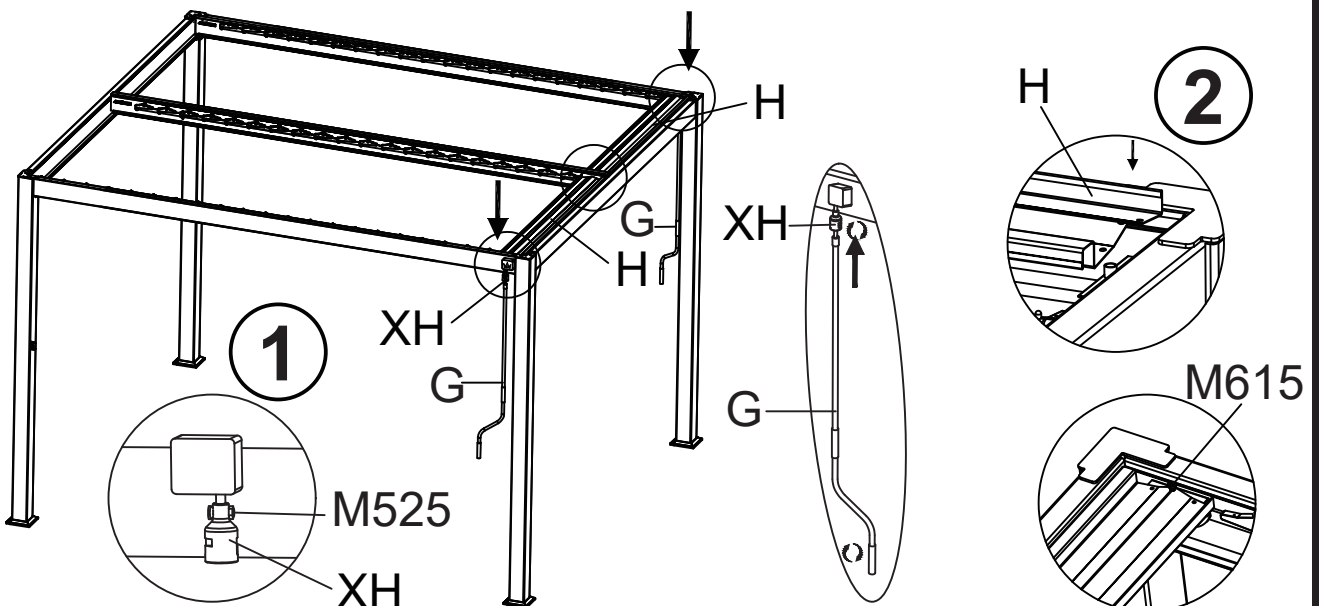

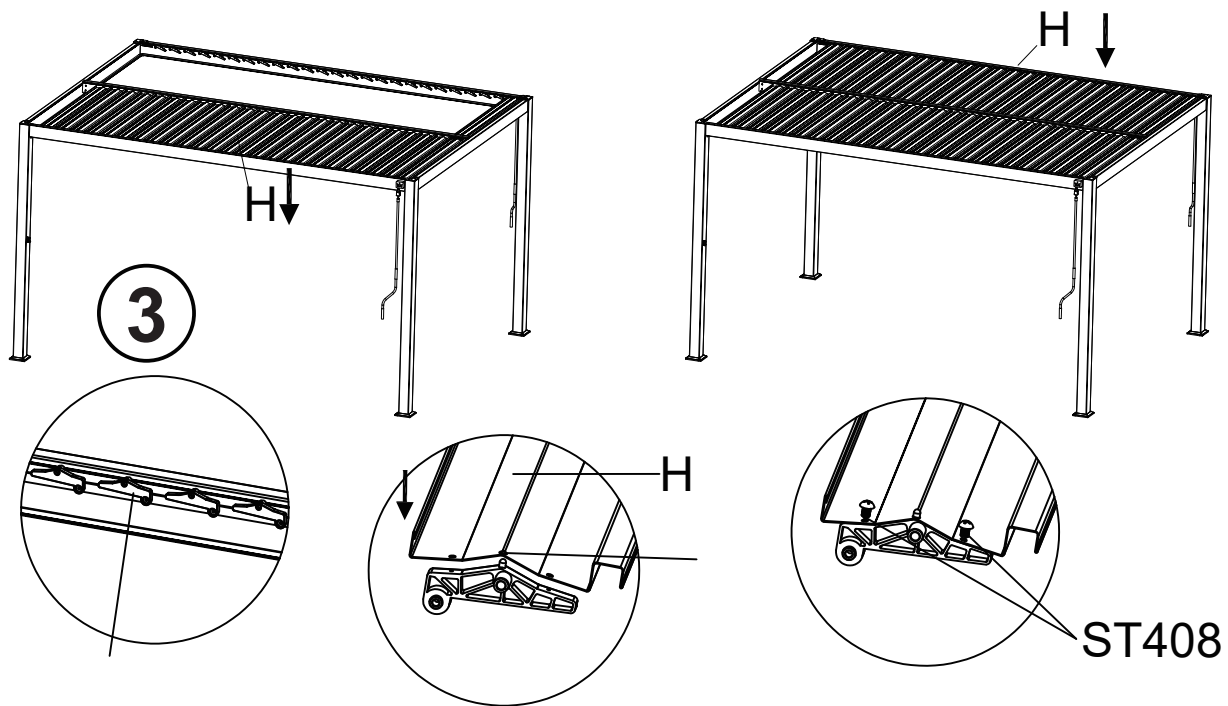

Step Eight

1. Attach the Louvre w/ Solar Panel (E1) to the Front Beam (B1) and Middle Beam (D) using Bolts (M625).
Connect the Cable of Solar Panel to the Cable Connector pre-equipped in the Front Beam (B1).
2. Attach the Louvre w/o Solar Panel (E2) to the Back Beam (B2) and Middle Beam (D) using Bolts (M625).

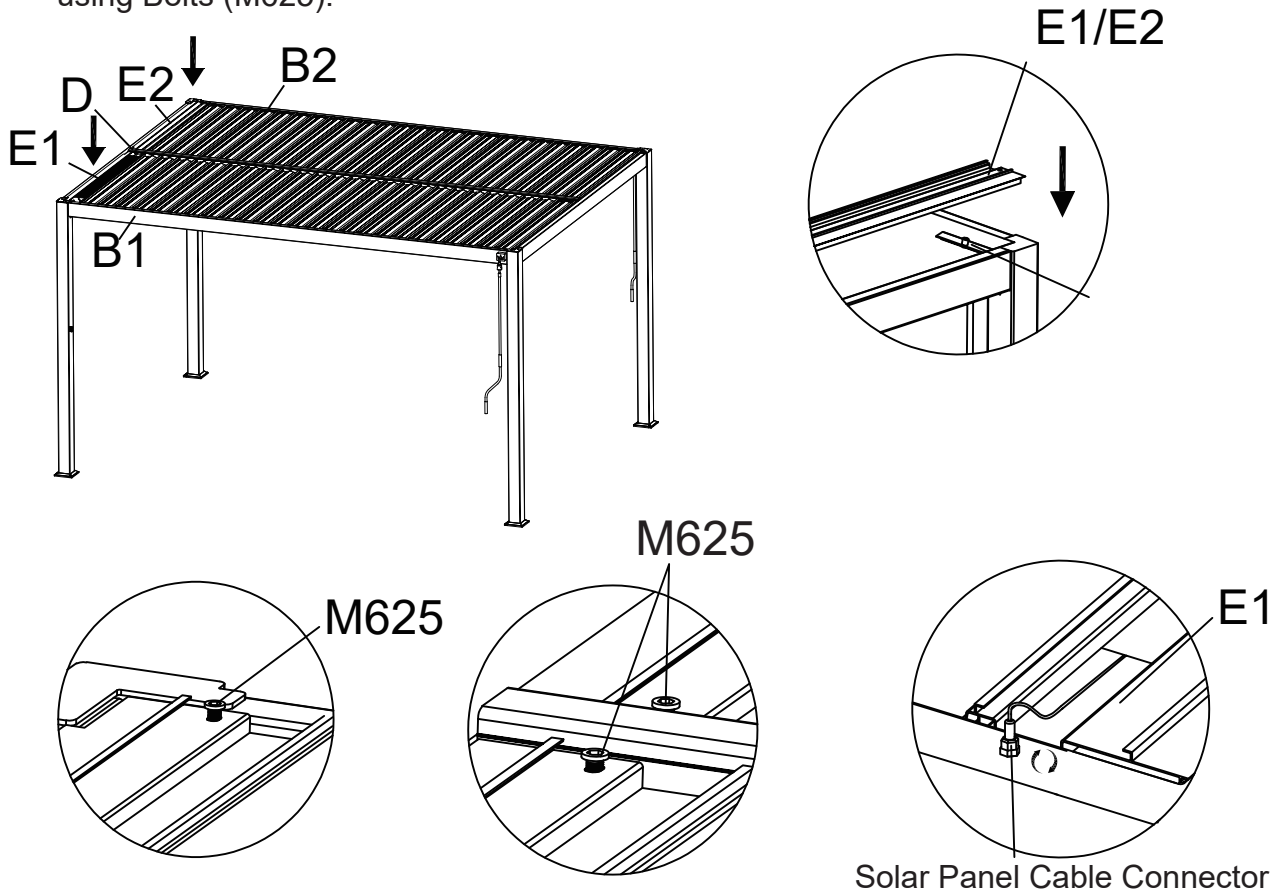

Step Nine

Pergola needs to be installed with the louvres following the incline of the patio to aid drainage.

Space Plates (F2) are provided to create this incline should your patio be perfectly level.

The Pergola should be secured on the Concrete Ground by Expansion Bolts (EB).

Note: Before locate the Expansion Bolts, please make sure the Distance between the Diagonal Posts is the same. As this is an import guarantee for the correct assembly of the Privacy Screens (Optional Parts) in the later step.

Please make sure the upper width is equal to bottom width between the Posts, namely $DA=DB$; $LA=LB$; $SA=SB$;

Use the Spirit Level (SL) with height of 1.4 Meter above the ground to make sure the Posts are vertically placed.

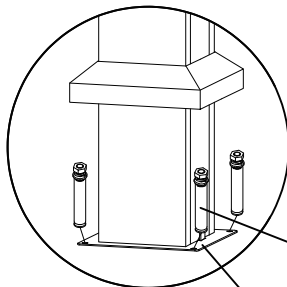
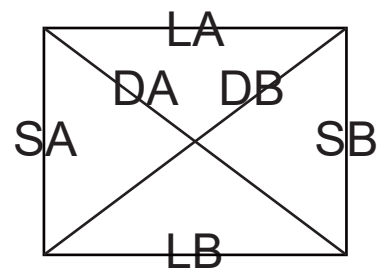
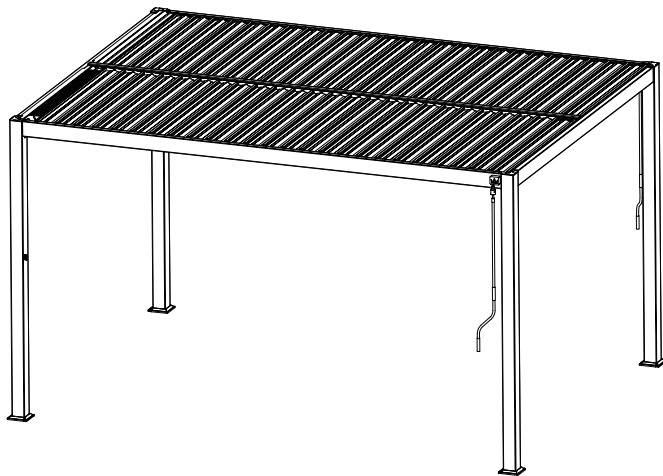

EB

XA

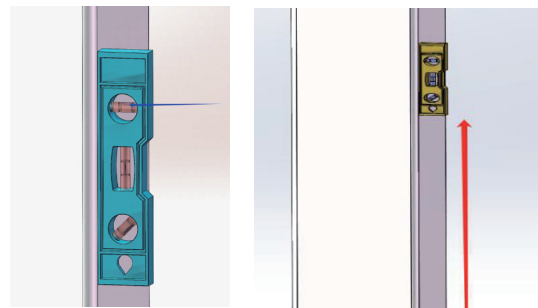

Tips:

Place Space Plates (F2) under the Leg Base to create the ideal incline before Securing the Expansion Bolts (EB).

Once the Privacy Screens have been assembled and you want to further add Space Plates (F2), please loosen the Screws (detach the Base Cover) like below and re-assemble the Base Cover when the Space Plates are added.

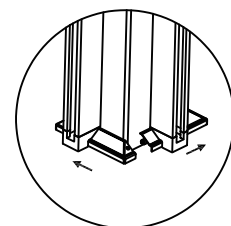
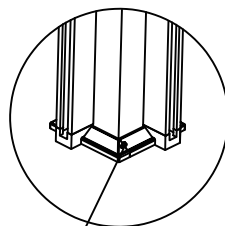
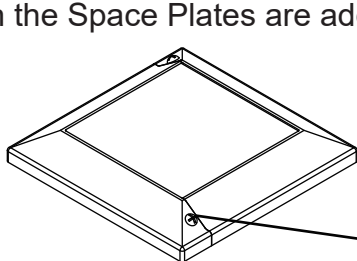

Loosen the screws

Step by step Use Instructions

To Open and Close the Louvre Roof

1. Manual Operation for Opening and Closing the Louvre Roof.

- 1) Use Crank Handle (G) to rotate the Rotating Ring (XH) Counter-Clockwise to Open.
- 2) Close the Louvre Roof by Opposite direction.

Do Not Over Rotate!

Note: The Louvre Roof can be stopped at any angle.

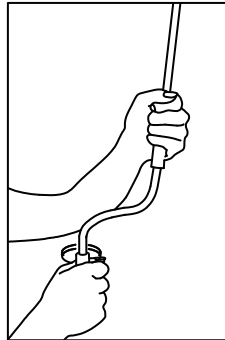

To Switch On and Switch Off the Led Lights:

1. Switch Use Instruction for Switching On and Switching Off the Led Lights

Just press the Button on Post w/ Switch (A2) to switch on or switch off the Led Lights.

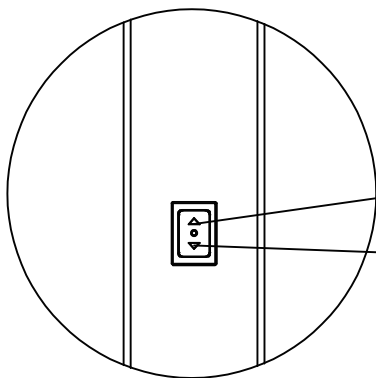

Press this Button to Switch On/Off the White Light

Press this Button to Switch On/Off the Warm Light

AFTERCARE

- Check and clear drainage channels regularly of any debris to ensure rainwater can continue to flow.
- Do not place objects on top of roof louvres.
- Use a soft nonabrasive cloth with warm soapy water to wipe clean any surfaces.
- Use a soft cloth with warm water to wipe solar panels occasionally to maintain maximum performance.
- A small bottle of Touch-Up Paint is provided which can be used for repairing small damaged area.

If you have any queries with regards to this product, please contact us at:

info@royalcraft.co.uk

This pergola is not fully rainproof. During periods of heavy rain, we recommend protecting any furniture placed underneath by using a rainproof furniture cover or storing the cushions in a waterproof storage box.

Need furniture to go under your pergola?

Visit www.royalcraft.co.uk for a wide range of garden furniture to suit.



PLEASE KEEP THESE INSTRUCTIONS FOR FUTURE REFERENCE