

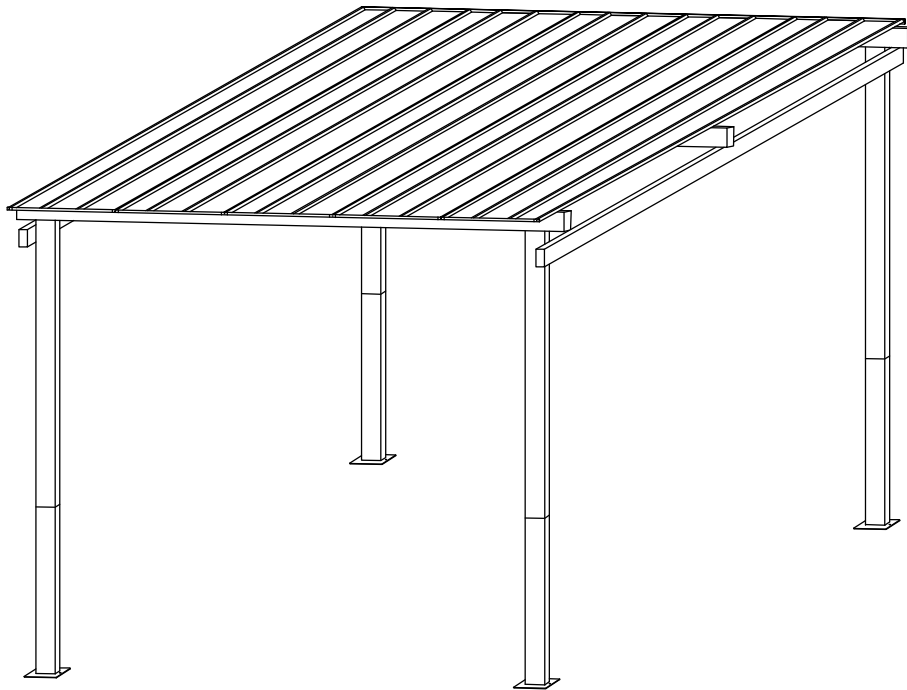

IN241000246V01\_GL

**84C-558V00**



**10**

**STEPS**



**3 HR**

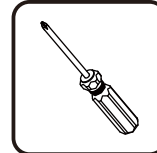
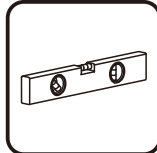
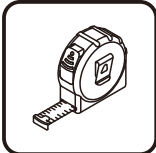
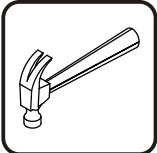
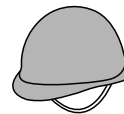

Tools Recommended

**EN\_IMPORTANT, RETAIN FOR FUTURE REFERENCE: READ CAREFULLY.**

**FR\_IMPORTANT: A LIRE ATTENTIVEMENT ET À CONSERVER POUR CONSULTATION ULTÉRIEURE.**

**ES\_IMPORTANTE, LEA Y GUARDE PARA FUTURAS REFERENCIAS.**

**PT\_IMPORTANTE, RETER PARA REFERÊNCIA FUTURA: LEIA ATENTAMENTE.**

**DE\_WICHTIG! SORFGFÄLTIG LESEN UND FÜR SPÄTERES NACHSCHLAGEN AUFBEWAHREN.**

**IT\_IMPORTANTE! CONSERVARE IL PRESENTE MANUALE PER FUTURO RIFERIMENTO E LEGGERLO ATTENTAMENTE.**

**EN****IMPORTANT SAFETY NOTICE**

Product is NOT INTENDED for the following:

- A safety barrier to prevent unsupervised access to pools, hot tubs, spas or ponds.
- As load bearing support for a building, structure, heavy objects or swings.
- Used in structures that trap wind, rain or snow that would create extra load on the product.

Accumulated snow must be removed from roof.

DO NOT climb or walk on roof for any reason.

Wear gloves to avoid injury from possible sharp edges of individual elements before assembly.

During installation, follow all safety warnings provided with your tools.

Some structures may require two or more people to install safely.

Check for underground utilities before digging or driving stakes into the ground!

It is important during assembly to closely follow the instructions, complete the assembly on a solid level surface and that you follow the instruction to square up, level and anchor the structure, this will reduce the gap at connections during assembly.

**FR****AVIS IMPORTANT DE SÉCURITÉ**

Le produit n'est PAS DESTINÉ à ce qui suit :

- Une barrière de sécurité pour empêcher l'accès non surveillé aux piscines, aux spas, aux cuves thermales ou aux étangs.
- Comme support de charge pour un bâtiment, une structure, des objets lourds ou des balançoires.
- Utilisé dans des structures qui retiennent le vent, la pluie ou la neige qui créeraient une charge supplémentaire sur le produit.

La neige accumulée doit être enlevée du toit.

NE PAS grimper ou marcher sur le toit pour quelque raison que ce soit.

Portez des gants pour éviter les blessures causées par d'éventuels bords tranchants des composants avant de procéder à l'assemblage.

Lors de l'installation, respectez tous les avertissements de sécurité fournis avec vos outils.

Certaines structures peuvent nécessiter l'intervention de deux personnes ou plus pour les installer en toute sécurité.

Vérifiez la présence de services publics souterrains avant de creuser ou de planter des piquets dans le sol !

Il est important, pendant tout le processus de montage, de suivre attentivement les instructions, de terminer l'assemblage sur une surface solide et plane et de suivre les instructions d'équerrage, de mise à niveau et d'ancrage de la structure, ce qui permettra de réduire les écarts au niveau des liaisons pendant le montage.

**ES****AVISO IMPORTANTE DE SEGURIDAD**

Manténgase alejado de las líneas eléctricas aéreas.

No coloque ni instale su tienda de campaña debajo de los árboles debido a posibles rayos o hundimiento de las ramas de los árboles en condiciones climáticas adversas. Para obtener las mejores condiciones en caso de viento fuerte, coloque el extremo estrecho de la tienda en la dirección del viento.

No dejes caer la tienda de campaña.

No haga rebotar ni golpee la bolsa de la tienda para sacarla, estas acciones podrían dañar el marco.

**ESTE PRODUCTO REQUIERE UN MÍNIMO DE DOS PERSONAS PARA SU MONTAJE**

Bajo ninguna circunstancia se debe utilizar este producto para cubrir automóviles, vehículos marinos o artículos similares.

**PRECAUCIÓN:** Vigile no pellizcarse los dedos durante el montaje y desmontaje de la tienda al unir las piezas del marco.

**PT****AVISO DE SEGURANÇA IMPORTANTE**

O produto NÃO é DESTINADO ao seguinte:

- Uma barreira de segurança para impedir o acesso sem supervisão a piscinas, banheiras, spas ou lagos.
- Como suporte de carga para um edifício, estrutura, objectos pesados ou baloiços.
- Usado em estruturas que apanham vento, chuva ou neve que criariam carga extra sobre o produto.

A neve acumulada deve ser removida do telhado. NÃO subir ou caminhar no telhado por qualquer razão.

Usar luvas para evitar ferimentos causados por possíveis arestas vivas de elementos individuais antes da montagem.

Durante a instalação, siga todos os avisos de segurança fornecidos com as suas ferramentas. Algumas estruturas podem exigir a instalação segura de duas ou mais pessoas. Verifique a existência de utilidades subterrâneas antes de escavar ou de conduzir estacas no solo!

É importante durante a montagem seguir de perto as instruções, completar a montagem numa superfície sólida e nivelar e ancorar a estrutura, o que reduzirá a folga nas ligações durante a montagem.

**DE****WICHTIGER SICHERHEITSHINWEIS**

Das Produkt ist NICHT für einen der folgenden Anwendungen bestimmt:

- Als Sicherheitsbarriere, die den unbeaufsichtigten Zugang zu Pools, Whirlpools, Spas oder Teichen verhindert.
- Als tragende Stütze für ein Gebäude, eine Struktur, schwere Gegenstände oder Schaukeln.
- Als Bestandteil einer Struktur verwendet werden, welche Wind, Regen oder Schnee abfangen, die eine zusätzliche Belastung für das Produkt darstellen würden.

Angesammelter Schnee muss vom Dach entfernt werden.

Aus keinem Grund darf das Dach bestiegen oder betreten werden.

Bitte tragen Sie stets geeignete Arbeitshandschuhe, um Verletzungen durch mögliche scharfe Kanten einzelner Elemente während der Montage zu vermeiden.

Befolgen Sie während des Installationsprozesses bitte sorgfältig alle Sicherheitswarnungen, die mit Ihren Werkzeugen geliefert werden.

Einige Strukturen können zwei oder mehr Personen erfordern, um sicher installiert zu werden.

Prüfen Sie vor dem Graben oder Eintreiben von Pfählen in den Boden, ob Erdkabel vorhanden sind!

Es ist wichtig, während der Montage die Anweisungen genau zu befolgen, Ihr Produkt auf einem festen und ebenen Untergrund aufzustellen und die Anweisung zum Aufrichten, Nivellieren und Verankern der Struktur zu befolgen, da dadurch der Spalt an den Verbindungen während der Montage verringert wird.

**IT****IMPORTANTI PRECAUZIONI DI SICUREZZA**

Il prodotto NON è PROGETTATO per quanto segue:

- Una barriera di sicurezza per impedire l'accesso senza supervisione a piscine, vasche idromassaggio, spa o stagni.
- Supporto portante di edifici, strutture, oggetti pesanti o altalene.
- Parte di strutture che accumulano vento, pioggia o neve, in quanto creerebbero un carico extra sul prodotto.

La neve accumulata deve essere rimossa dal tetto.

NON salire o camminare sul tetto per nessun motivo.





Indossare guanti per evitare lesioni derivanti da spigoli vivi dei singoli componenti prima del montaggio.





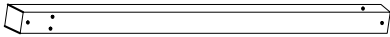
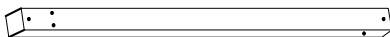
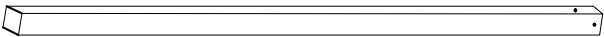
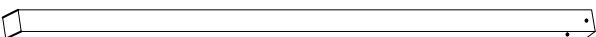
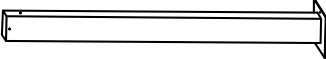



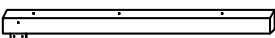
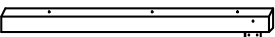
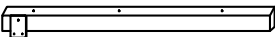
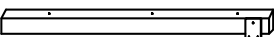
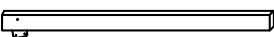
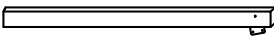
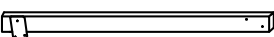

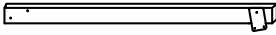
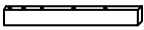

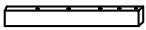

Durante l'installazione, seguire tutte le precauzioni di sicurezza fornite con gli strumenti.





Alcune strutture possono richiedere due o più persone per essere installate in sicurezza.



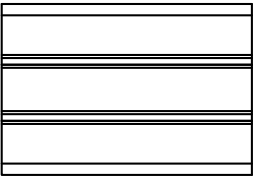

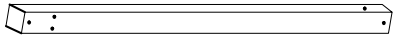
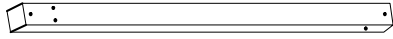
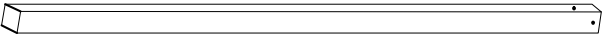
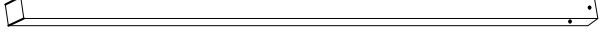
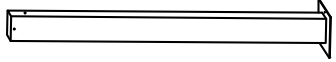

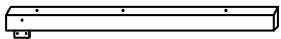
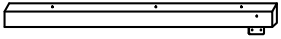
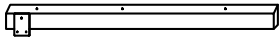
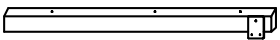
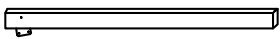
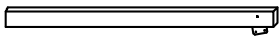
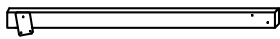
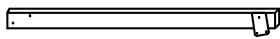
Controlla le utenze sotterranee prima di scavare o piantare pali nel terreno!

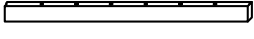
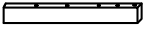



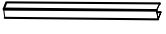

È importante che durante il montaggio vengano seguite attentamente le istruzioni, inoltre completare il montaggio su una superficie piana e solida e seguire le istruzioni per allineare, livellare e ancorare la struttura, in quanto questo ridurrà lo spazio necessario durante il montaggio.

	PART NO	DESCRIPTION	QTY
<b>CARTON 1/3</b>	<b>A1</b>		<b>1</b>
	<b>A2</b>		<b>1</b>
	<b>A3</b>		<b>1</b>
	<b>A4</b>		<b>1</b>
	<b>A5</b>		<b>4</b>
	<b>A6</b>		<b>4</b>
	<b>E1</b>		<b>6</b>
	<b>E2</b>		<b>6</b>
	<b>K2</b>		<b>4</b>
<b>CARTON 2/3</b>	<b>B1</b>		<b>1</b>
	<b>B2</b>		<b>1</b>
	<b>B3</b>		<b>1</b>
	<b>B4</b>		<b>1</b>
	<b>C1</b>		<b>1</b>
	<b>C2</b>		<b>1</b>
	<b>C3</b>		<b>1</b>

	PART NO	DESCRIPTION				QTY	
CARTON 2/3	C4					1	
	D1					1	
	D2					1	
	D3					1	
	K1		2		T1		10
	T2		10		V		12
	#1	 M6X15	72		#2	 M6X20	12
	#3	 M6X45	28		#4	 M6X100	2
	#5		4		#6		1
	#7		1				
CARTON 3/3	AA					5	
	BB					5	

PART NO	DESCRIPTION	QTY	PART NAME
A1		1	
A2		1	
A3		1	
A4		1	
A5		4	
A6		4	
B1		1	
B2		1	
B3		1	
B4		1	
C1		1	
C2		1	
C3		1	
C4		1	
D1		1	
D2		1	
D3		1	

PART NO	DESCRIPTION	QTY	PART NANE
E1		6	
E2		6	
K1		2	
K2		4	
T1		10	
T2		10	
V		12	

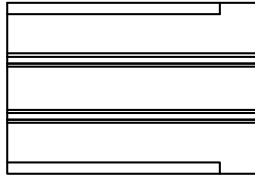
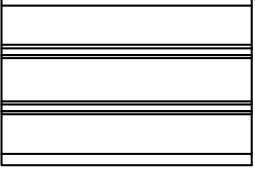
PART NO	DESCRIPTION	QTY	PART NAME
#1	 M6X15	72	
#2	 M6X20	12	
#3	 M6X45	36	
#4	 M6X100	2	
#5		4	
#6		1	
#7		1	
AA		5	
BB		5	

1

EN\_ Each leg tube is fixed with 4 bolts  
 FR\_ Chaque tube de jambe est fixé par 4 boulons  
 ES\_ Cada tubo de la pata se fija con 4 pernos  
 PT\_ Cada tubo de perna é fixado com 4 parafusos  
 DE\_ Jedes Beinrohr ist mit 4 Schrauben befestigt  
 IT\_ Ogni tubo della gamba è fissato con 4 bulloni

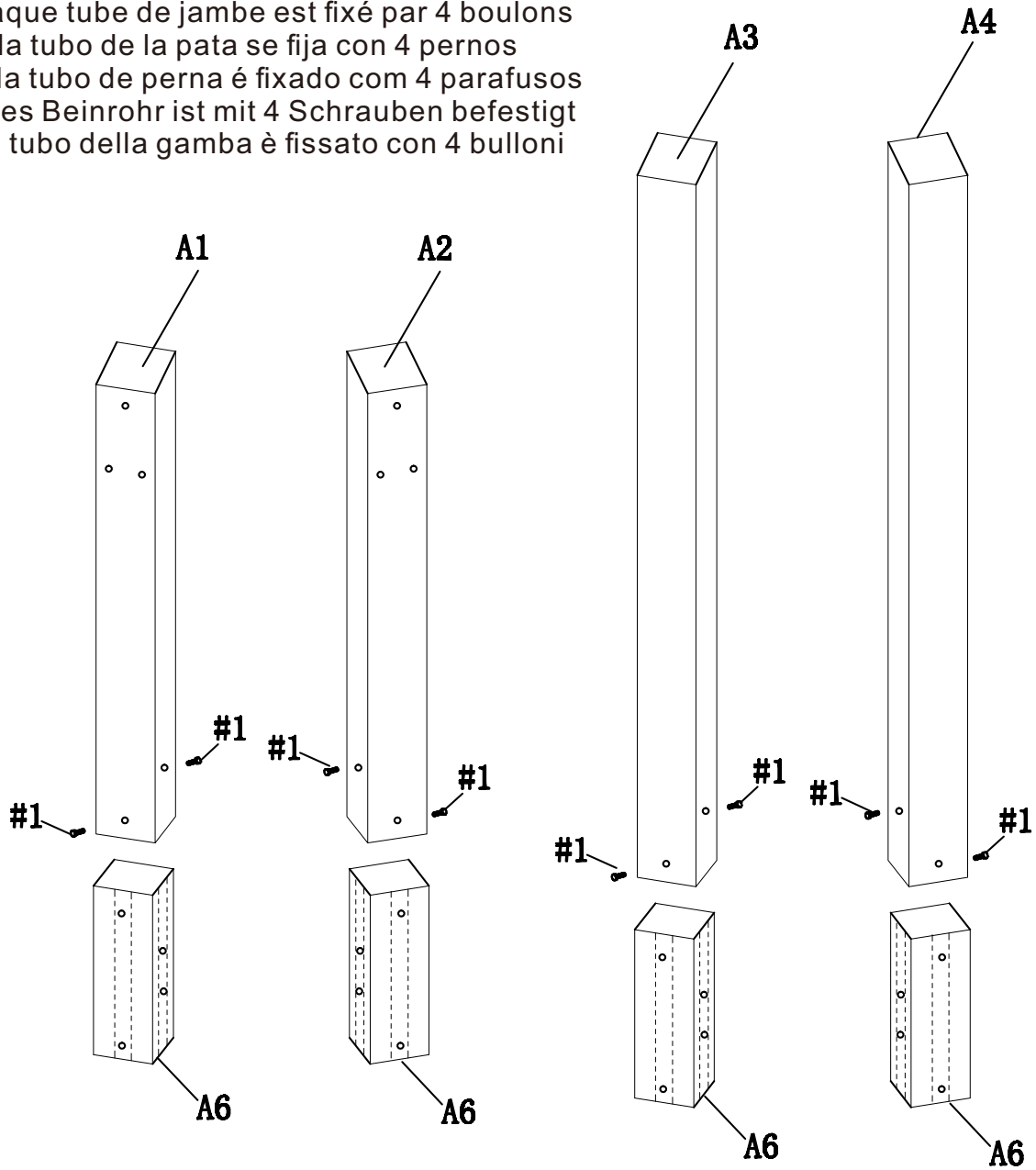

<b>A1</b>		<b>X1</b>	<b>A2</b>		<b>X1</b>
<b>A3</b>		<b>X1</b>	<b>A4</b>		<b>X1</b>
<b>A6</b>		<b>X4</b>	<b>#1</b>	<b>M6X15</b>	<b>X16</b>

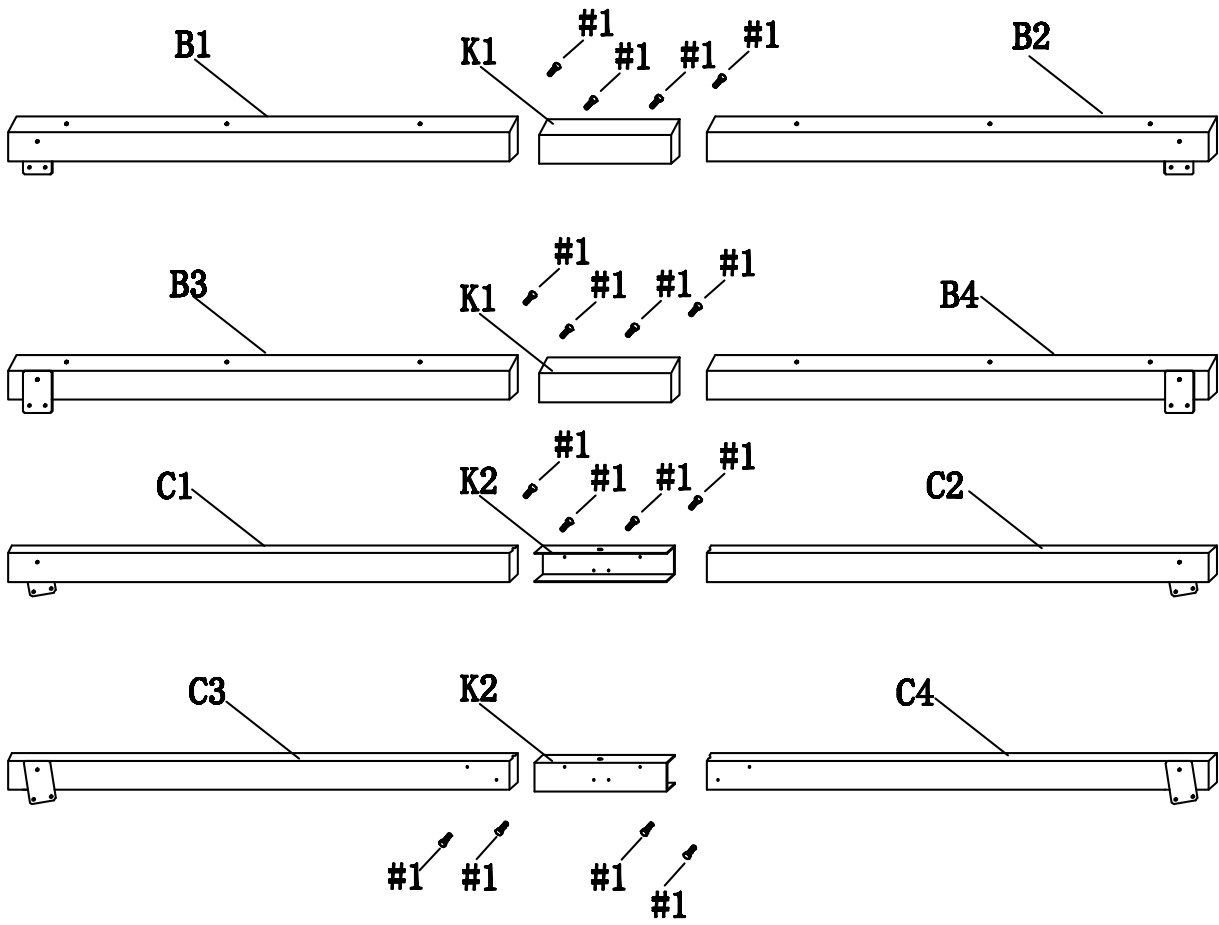

2



<b>B1</b>		X1	<b>B2</b>		X1
<b>B3</b>		X1	<b>B4</b>		X1
<b>C1</b>		X1	<b>C2</b>		X1
<b>C3</b>		X1	<b>C4</b>		X1
<b>K1</b>		X2	<b>K2</b>		X2
<b>#1</b>	M6X15	X16			

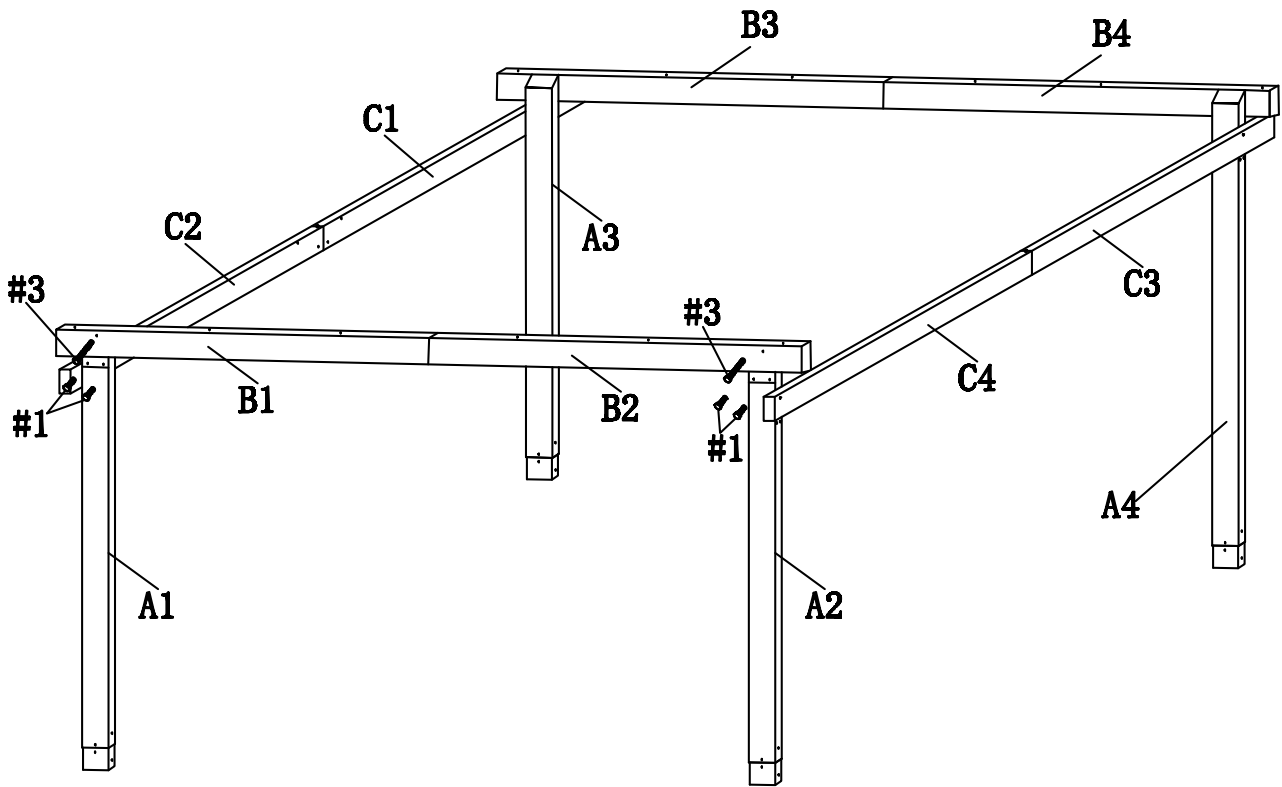





3

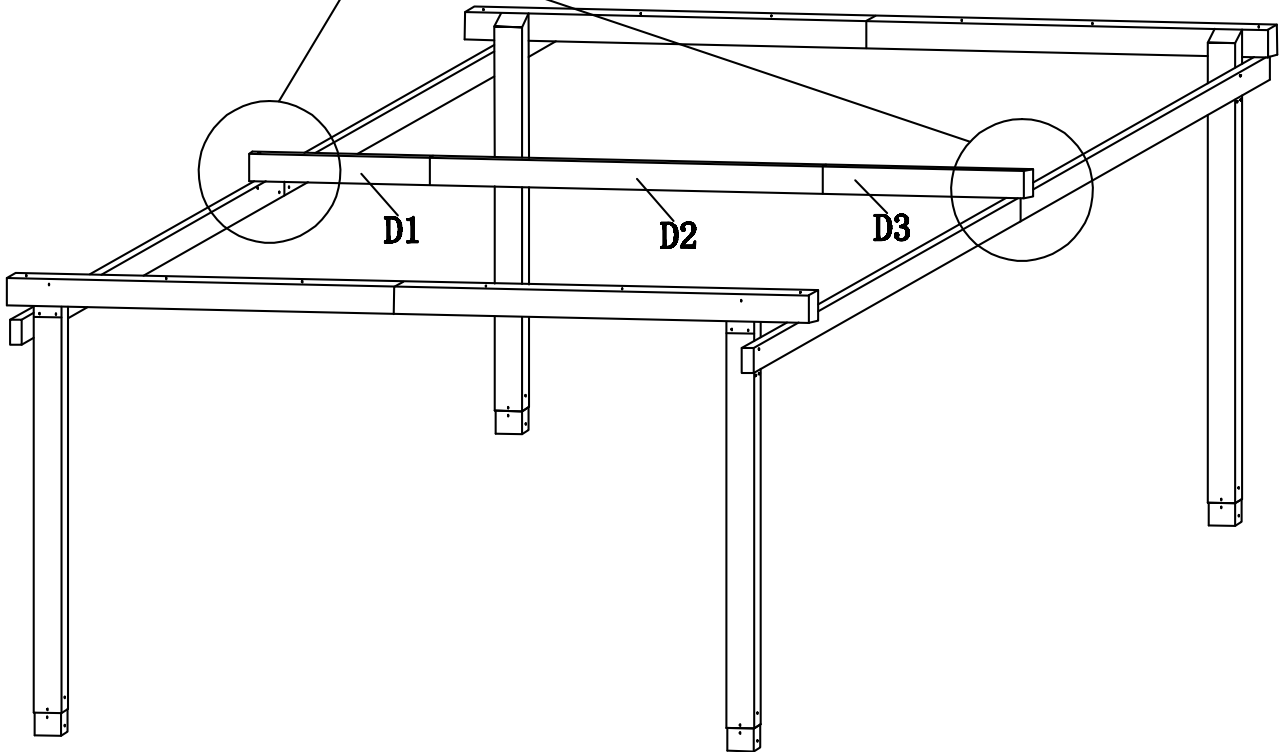
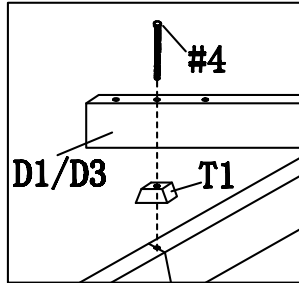
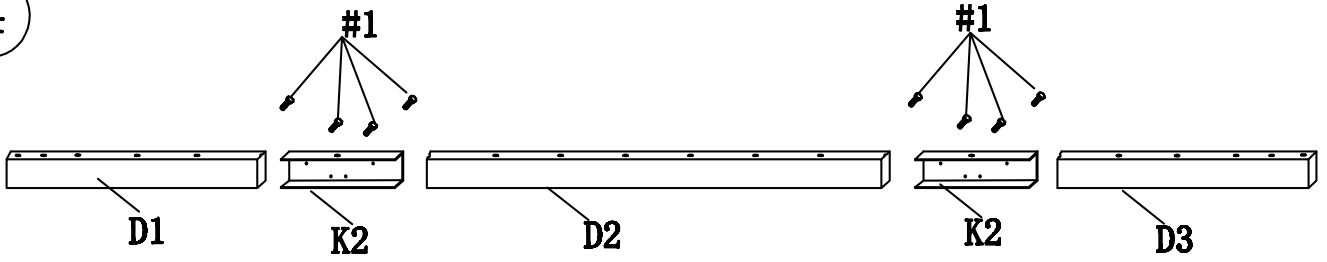

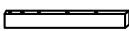
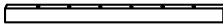
#1	 M6X15	X16	#3	 M6X45	X8



4

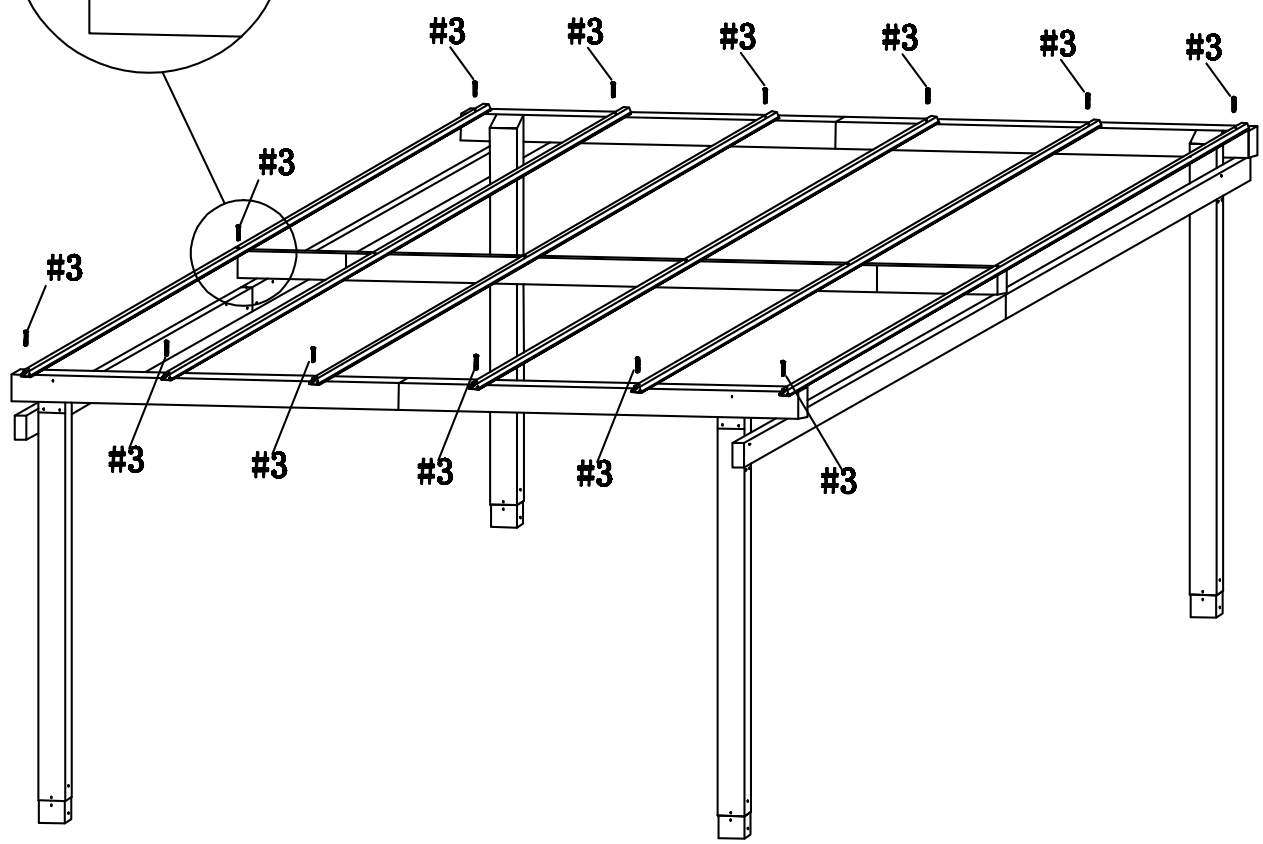
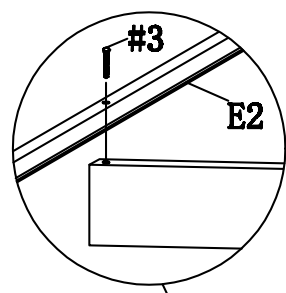
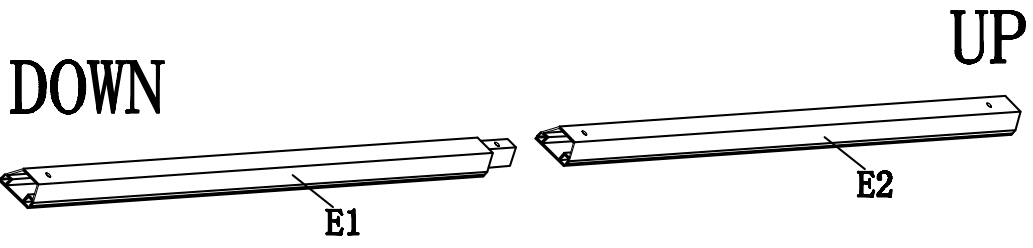

<b>D1</b>		<b>x1</b>	<b>D2</b>		<b>x1</b>
<b>D3</b>		<b>x1</b>	<b>K2</b>		<b>x2</b>
<b>T1</b>		<b>x2</b>	<b>#1</b>	 <b>M6X15</b>	<b>x8</b>
<b>#4</b>	 <b>M6X100</b>	<b>x2</b>			

5



E1		X6	E2		X6
#3	 M6X45	X18			

6

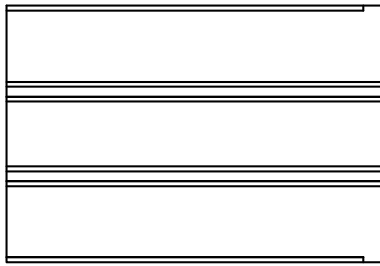

AA

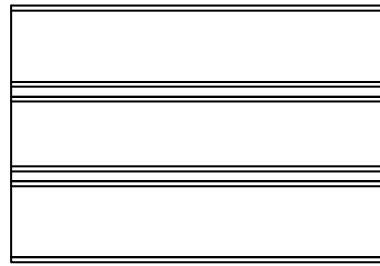

BB

EN\_AA (with gap)  
 FR\_AA (avec lacune)  
 ES\_AA (con hueco)  
 PT\_AA (com intervalo)  
 DE\_AA (mit Lücke)  
 IT\_AA (con lacuna)

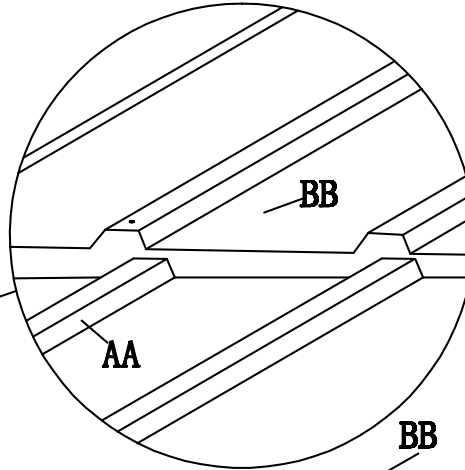
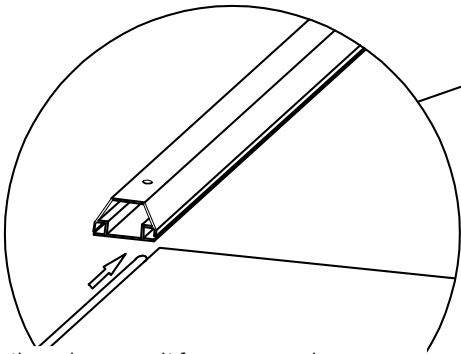

EN\_AA is placed below BB.  
 FR\_AA est placé en dessous de BB.  
 ES\_AA se sitúa por debajo de BB.  
 PT\_AA é colocado abaixo de BB.  
 DE\_AA wird unter BB eingeordnet.  
 IT\_AA è posizionato sotto BB.



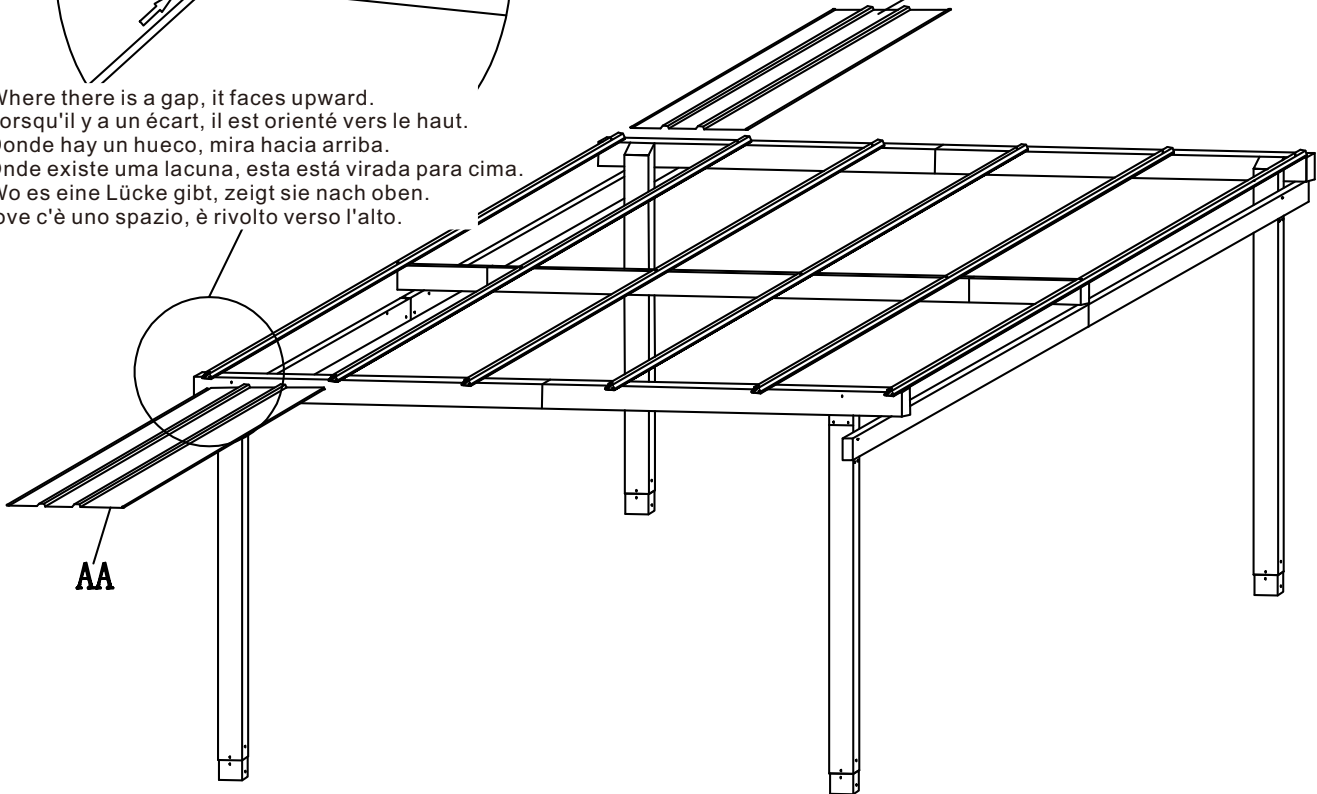

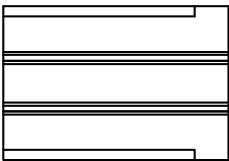
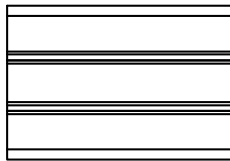
EN\_ Where there is a gap, it faces upward.  
 FR\_ Lorsqu'il y a un écart, il est orienté vers le haut.  
 ES\_ Donde hay un hueco, mira hacia arriba.  
 PT\_ Onde existe uma lacuna, esta está virada para cima.  
 DE\_ Wo es eine Lücke gibt, zeigt sie nach oben.  
 IT\_ Dove c'è uno spazio, è rivolto verso l'alto.

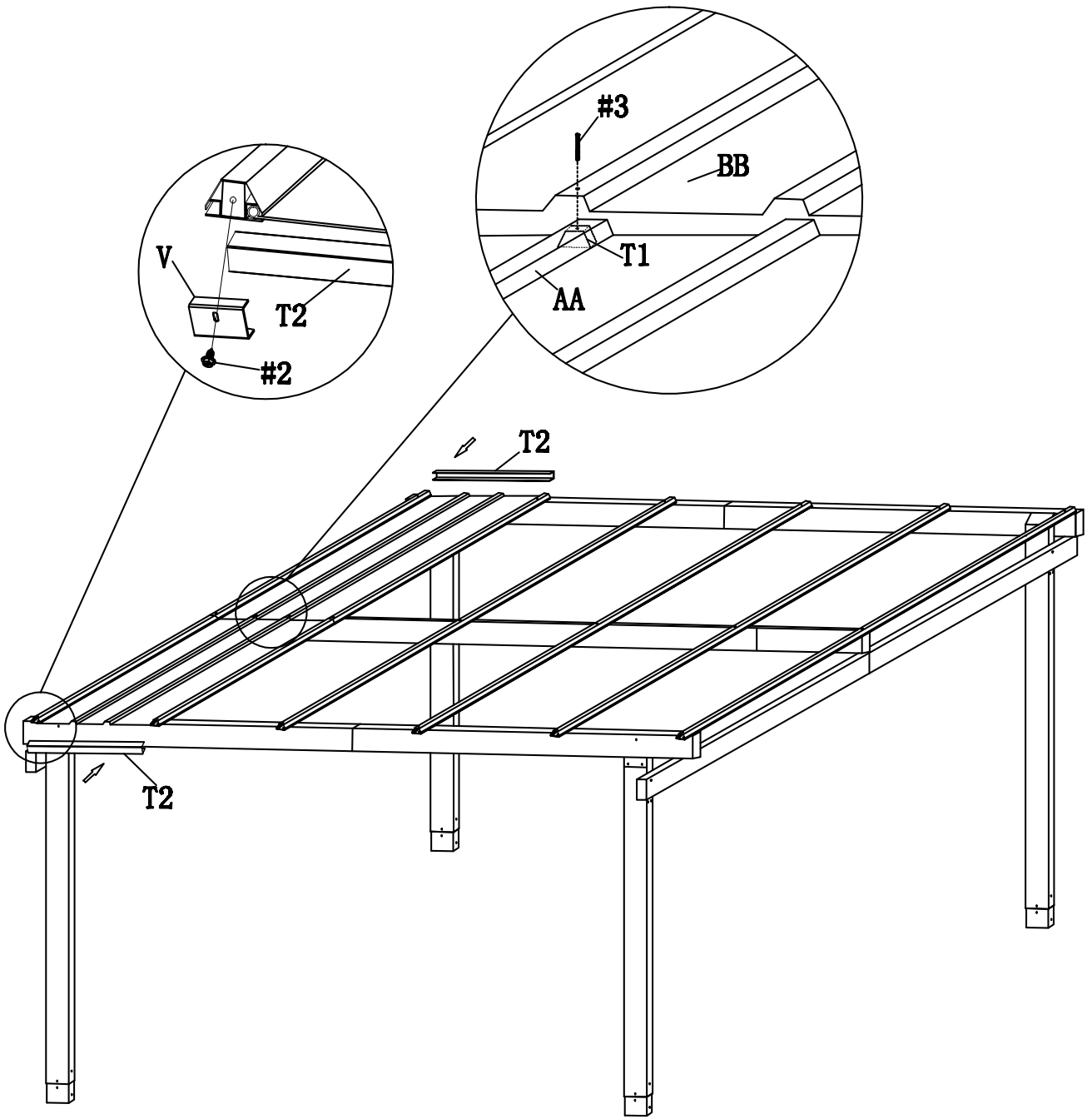

AA		x1	BB		x1
----	---	----	----	---	----

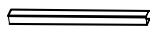





7

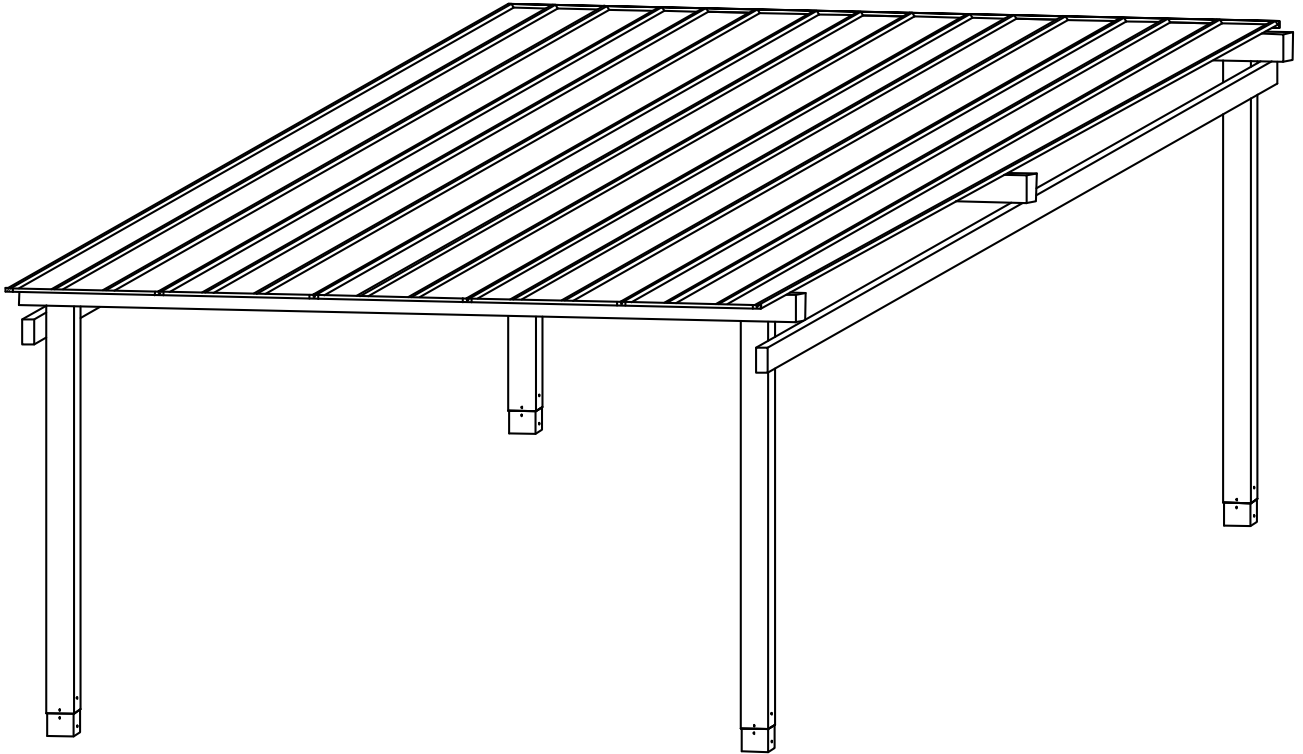

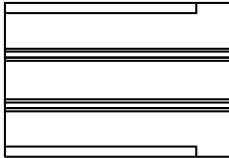
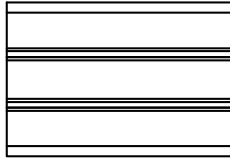
T1		x2	T2		x2
V		x2	#2	 M6X20	x2
#3	 M6X45	x2			

8





<b>AA</b>		<b>x4</b>	<b>BB</b>		<b>x4</b>
<b>T1</b>		<b>x8</b>	<b>T2</b>		<b>x8</b>
<b>V</b>		<b>x10</b>	<b>#2</b>	 <b>M6X20</b>	<b>x10</b>
<b>#3</b>	 <b>M6X45</b>	<b>x8</b>			

9

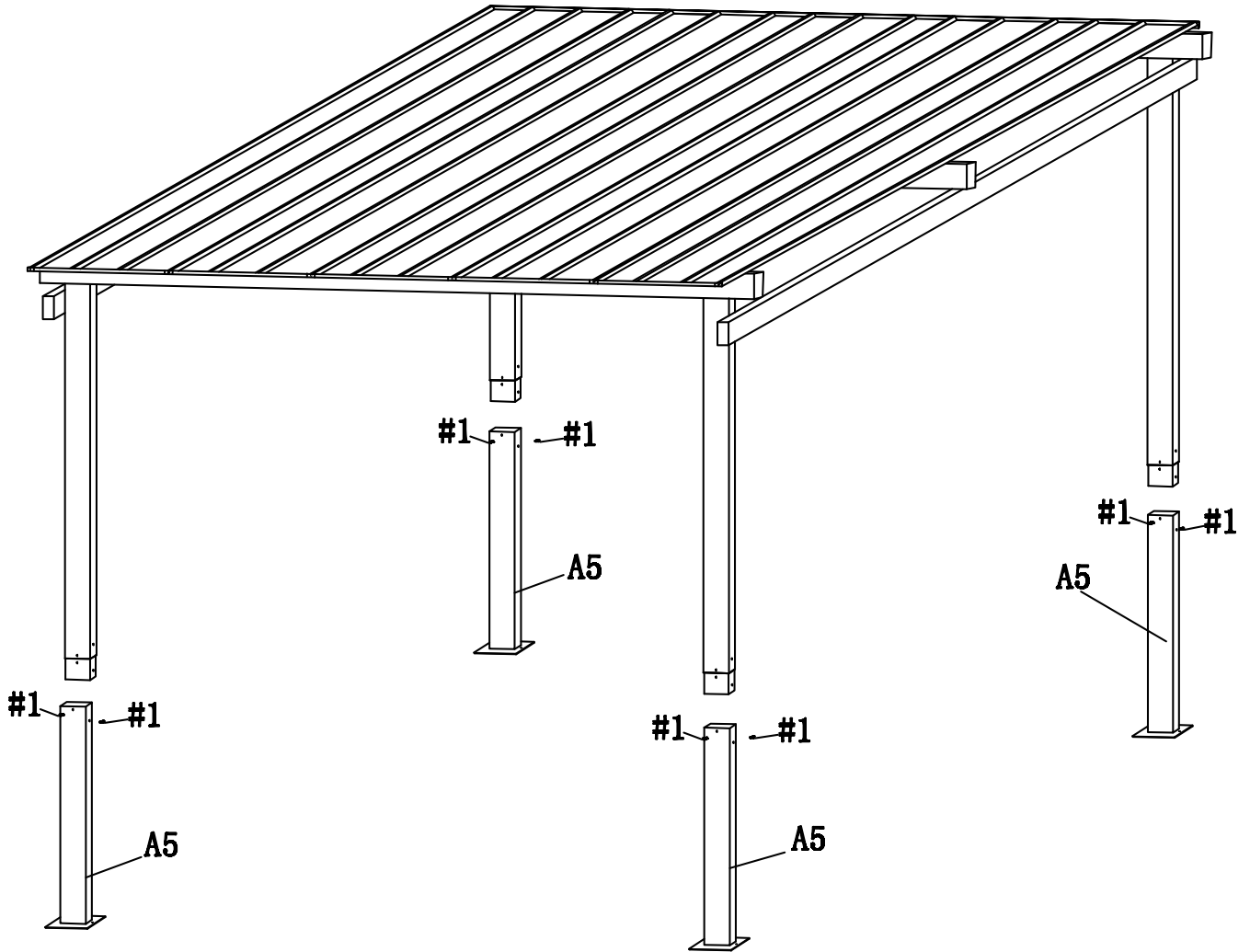
**EN** Each leg tube is fixed with 4 bolts  
**FR** Chaque tube de jambe est fixé par 4 boulons  
**ES** Cada tubo de la pata se fija con 4 pernos  
**PT** Cada tubo de perna é fixado com 4 parafusos  
**DE** Jedes Beinrohr ist mit 4 Schrauben befestigt  
**IT** Ogni tubo della gamba è fissato con 4 bulloni

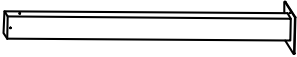

<b>A5</b>		<b>X4</b>	<b>#1</b>	 <b>M6X15</b>	<b>X16</b>

10

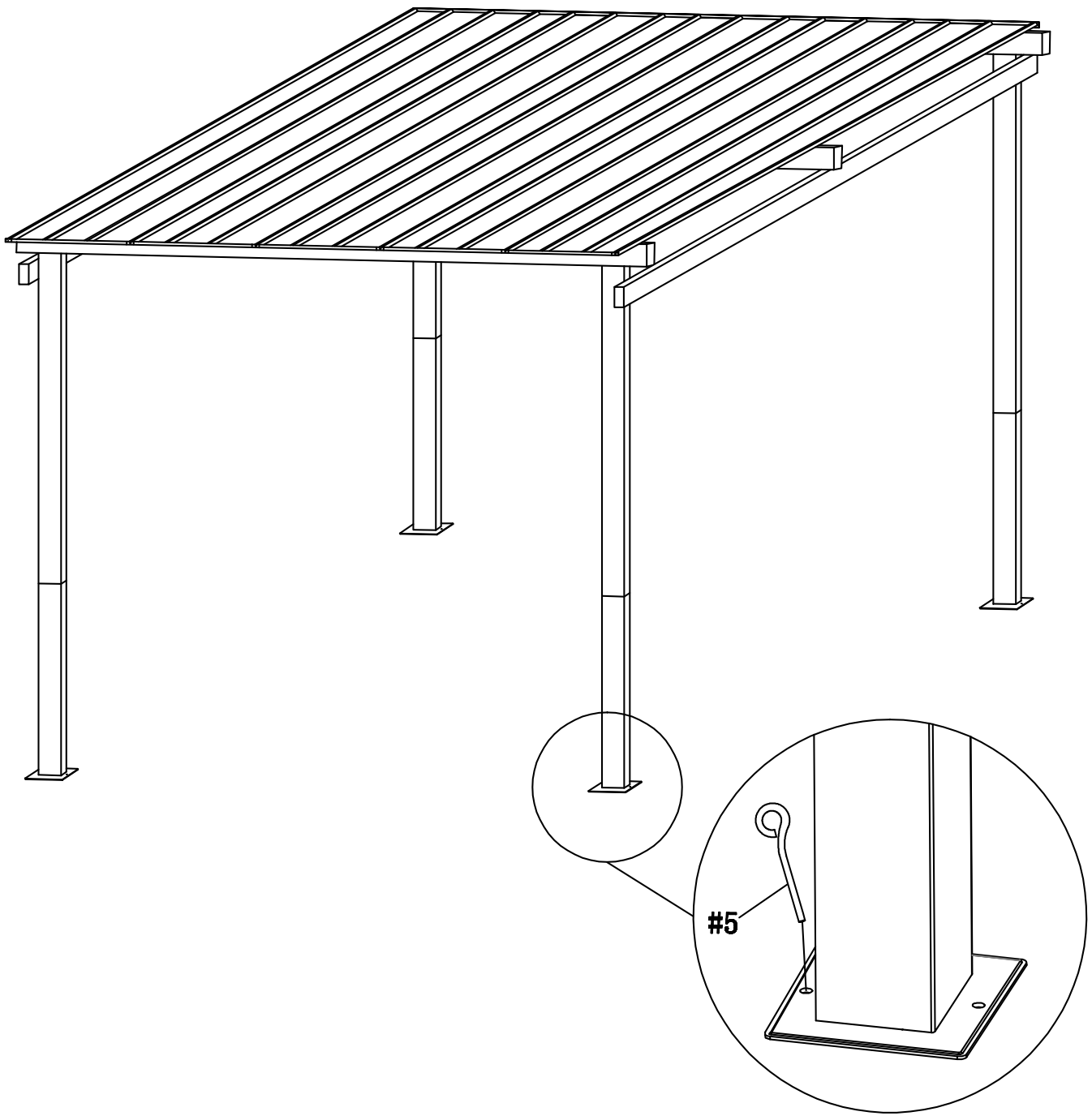

#5		X4			

If you have any questions, please contact our customer care center, Our contact details are below:

**US**

 001-877-644-9366

 customerservice@aosom.com

Imported by Aosom LLC  
27150 SW Kinsman Rd Wilsonville, OR 97070 USA  
MADE IN CHINA

If you have any questions, please contact our customer care center, Our contact details are below:

**CA**

 416-792-6088

 customerservice@aosom.ca

Imported by Aosom Canada Inc.  
7270 Woodbine Avenue, Unit 307, Markham,  
Ontario Canada L3R 4B9  
MADE IN CHINA

Si vous avez la moindre question, veuillez contacter notre centre d'assistance à la clientèle, Nos coordonnées sont les suivantes:

 416-792-6088

 customerservice@aosom.ca

Importé par Aosom Canada Inc.  
7270 Woodbine Avenue, unité 307,  
Markham, Ontario Canada L3R 4B9  
FABRIQUÉ EN CHINE

If you have any questions, please contact our customer care center, Our contact details are below:

**UK**

 0044-800-240-4004

 enquiries@mhstar.co.uk

IMPORTER ADDRESS:  
MH STAR UK LTD  
Unit 27, Perivale Park,  
Horsenden lane South  
Perivale, UB6 7RH  
MADE IN CHINA

Si vous avez la moindre question, veuillez contacter notre centre d'assistance à la clientèle, Nos coordonnées sont les suivantes:

**FR**

 0033-1-84166106

 aosom@mhfrance.fr

Importé par/Fabricant/REP:  
MH FRANCE  
2 Rue Maurice Hartmann  
92130 Issy Les Moulineaux  
France  
FABRIQUÉ EN CHINE

Wenn Sie Fragen haben, wenden Sie sich bitte an unser Kundendienstzentrum, Unsere Kontaktdaten stehen unten:

**DE**

 0049-0(40)-88307530

 service@aosom.de

ADRESSE DES IMPORTEURE/Hersteller/REP:  
MH Handel GmbH  
Wendenstraße 309  
D-20537 Hamburg  
Germany  
IN CHINA HERGESTELLT

In caso di dubbio, si prega di contattare il nostro centro assistenza clienti, I nostri dettagli di contatto sono di seguito:

**IT**

 0039-0249471447

 clienti@aosom.it

IMPORTATO DA/Produttore/REP:  
AOSOM Italy srl  
Centro Direzionale Milanofiori  
Strada 1 Palazzo F1  
20057 Assago (MI)  
P.I.: 08567220960  
FATTO IN CINA

Si tiene alguna pregunta, comuníquese con nuestro Centro de Atención al Cliente, Nuestros datos de contacto son los siguientes:

**ES**

 0034-931294512

 atencioncliente@aosom.es

IMPORTADOR/Fabricante/REP:  
SPANISH AOSOM, S.L.  
C/ROC GROS, N°15.08550, ELS HOSTALETS DE  
BALENYÀ, SPAIN.  
B66295775  
HECHO EN CHINA

Se tiver alguma dúvida, por favor contacte o nosso Centro de Atendimento ao Cliente, Os nossos dados de contacto são os seguintes:

**PT**

 0034-931294512

 info@aosom.pt.

IMPORTADOR/Fabricante/REP:  
SPANISH AOSOM, S.L.  
C.ROC GROS N.15, 08550. ELS HOSTALETS DE  
BALENYÀ  
FEITO NA CHINA



**FR**

**DONNEZ  
OU  
RECYCLEZ**



ASSOCIATION

OU



LIVRAISON

OU



DÉCHÈTERIE

Adresses sur [quefairedemesdechets.fr](http://quefairedemesdechets.fr)